

Part number



CSHF 16 N



Brief description:

female insert, 16 poles + PE, No. 17 - 32, Spring connection contacts SQUICH, 16A, 500V, 3, silver plated, size "77.62", CLASS insert series

Product description	
Model	female insert
Version	SQUICH® Spring connection contacts
Series	CSH
Product type	with female contacts
Family	CLASS inserts
Size	size "77.62"
N. of poles	32 poles +  (2 inserts)
Technical data	
Current	16 A (A.C. and D.C.)
Voltage	500 V
Pollution degree	3
Wire cross-section	0,14 mm ² - 2,50 mm ²
AWG size	26 - 14
Operating temperature range (min, max)	-50°C ... +70°C
Contact type	silver plated
Mating cycles	≥ 200
IP degree of protection	IP20 without enclosure, IP65/IP66 with enclosure
Further technical details	
Characteristics according to EN 61984	16A 500V 6kV 3; 16A 400/690V 6kV 2
Insulation resistance	≥ 1 GΩ
Rated voltage according to UL/CSA	600V
UL 94 flammability rating	V-0
Weight	108,00 g

Approvals / Standards	
Reference standard	EN 61984 (2001-11)
Quality mark	   EAC
Conformity	CQC, CE
General ordering information	
EAN13 code	8015747170802
Tariff number	85369095
Country of origin	Made in EU (IT)
ETIM classification	EC000438
Packaging Information	
Packaging length	245,00 mm
Packaging height	165,00 mm
Packaging width	215,00 mm
Packaging weight	3,25 kg
Packaging volume	8,69 dm ³
Packaging description	Carton box
Packaging quantity	30 Pcs
Packaging EAN code	8015747170840
Sub-packaging length	197,00 mm
Sub-packaging height	44,00 mm
Sub-packaging width	113,00 mm
Sub-packaging weight	0,54 kg
Sub-packaging volume	0,98 dm ³
Sub-packaging description	Carton
Sub-packaging quantity	5 Pcs
Sub-packaging EAN barcode	8015747170857

Part number

CSHF 16 N



Catalogue drawings

Catalogue drawings

dimensions in mm

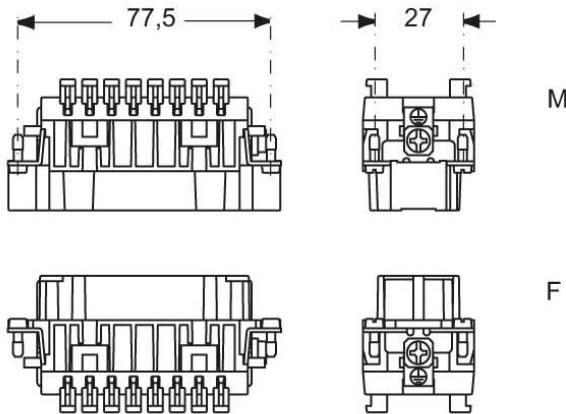

contacts side (front view)

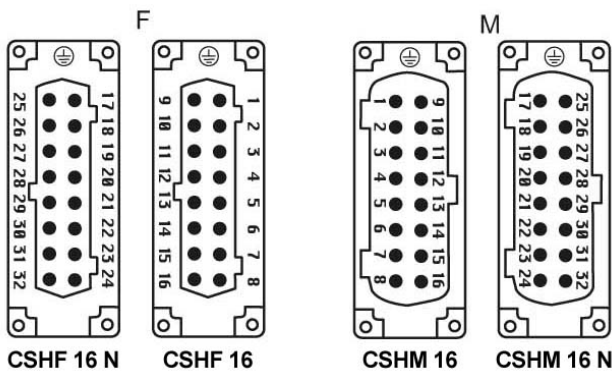
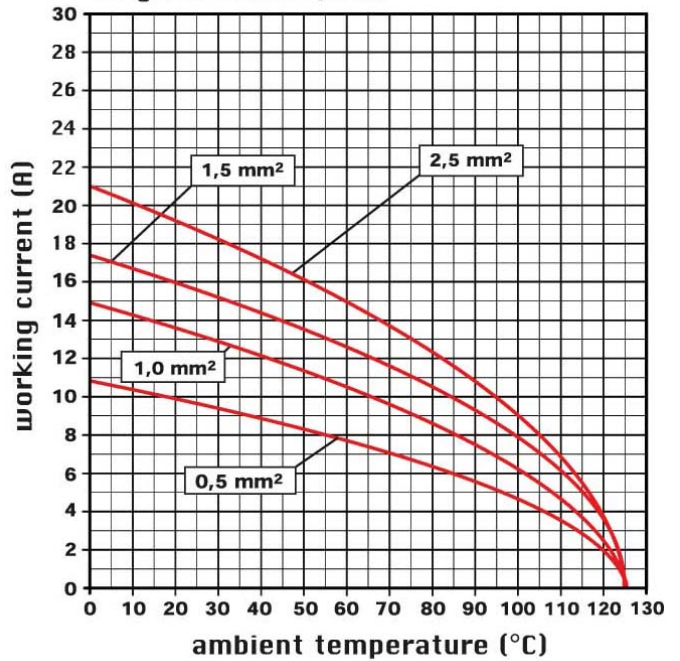

diagram CSH 32 poles



Notes

CSHF/M 16 N

- characteristics according to EN 61984:

16A 500V 6kV 3

16A 400/690V 6kV 2

- rated voltage according to UL/CSA: 600V

- insulation resistance: > 10 GOhm

- ambient temperature limit: -40 °C ... +125 °C

- are made of self-extinguishing thermoplastic resin UL 94 V0

- mechanical life: > 500 cycles

- contact resistance: < 3 mOhm

- enclosures: size "77.27":

C-TYPE IP65/IP66

W-TYPE aggressive environments

actuator button connections

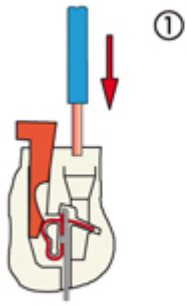

①

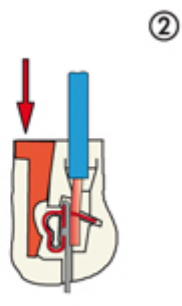

②

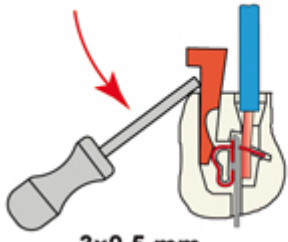

3x0,5 mm

Reopening
